



# Varley Collection

Colours represented are to be used as a guide only.  
Please refer to manufacturers swatch for a more accurate colour match.

Please note that colour shadings can vary slightly from each roll of fabric.  
We cannot guarantee a precise match to these samples or between cut lengths and upholstered goods.

foamflex™  
Award Winning Seating Technology

12/04/2024

# VARLEY COVER GUIDE: STANDARD BACK ONLY

Please use this guide when ordering the following pieces to clarify cover options.

Corner Group: LH2, COR, RH2

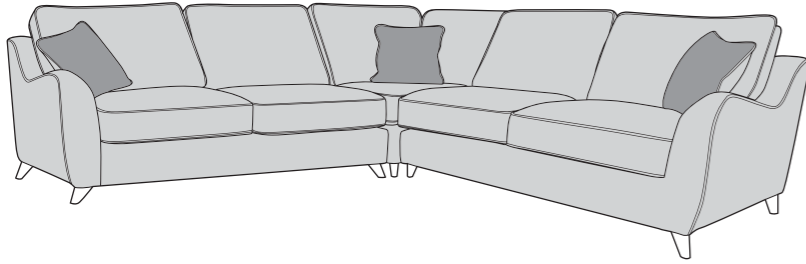

Corner Group: LH2, RFC, FST

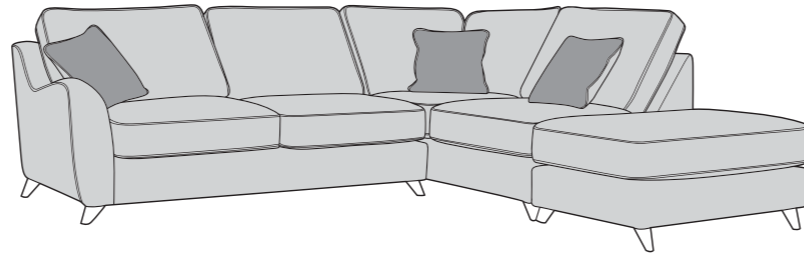

Corner Group: FST, LFC, RH2

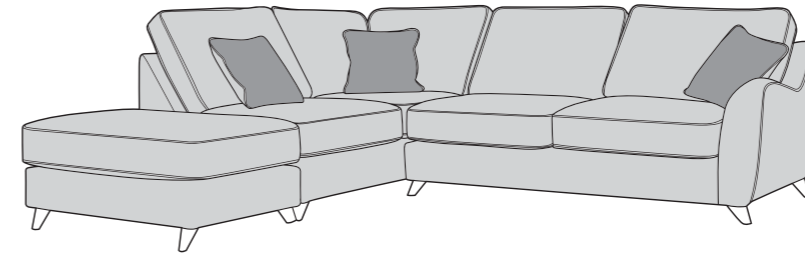

Corner Group: LH2, COR, RH1

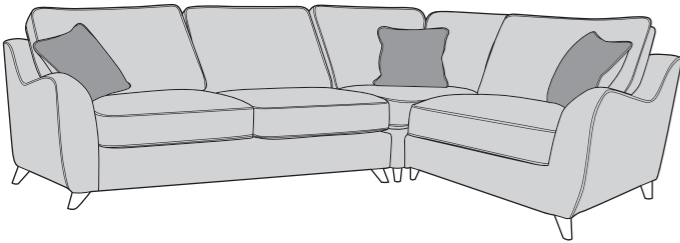

Corner Group: LH1, COR, RH2

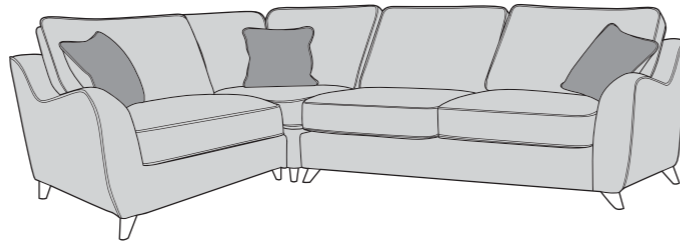

Corner Group: LH1, COR, RH1

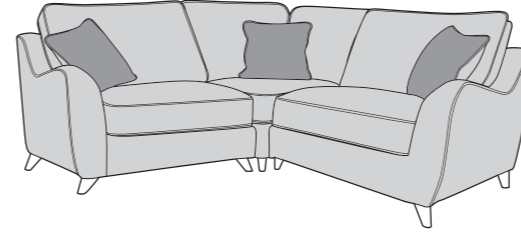

Armless Unit (ALU)

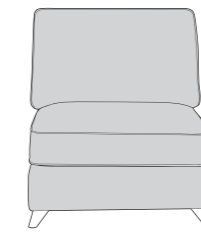

3 Seater Sofa (3ST)

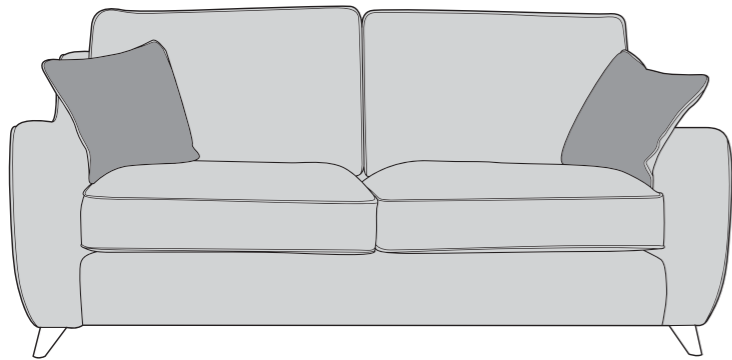

2 Seater Sofa (2ST)

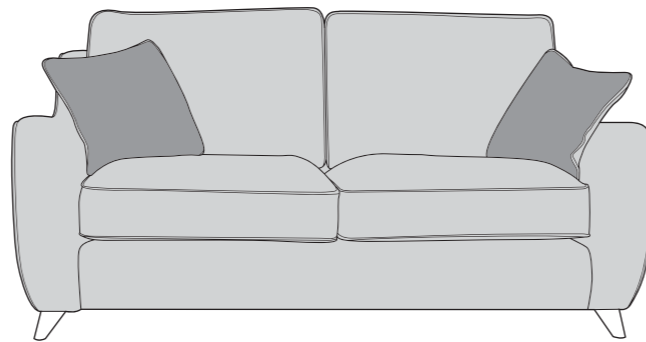

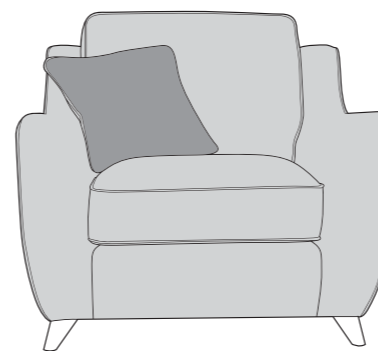

Arm Chair (1ST)

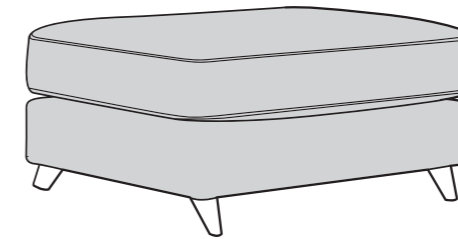

Footstool P (FST)



 **COVER 1**  
(BODY)

 **COVER 2**  
(SCATTER)

## Scatter Cushion

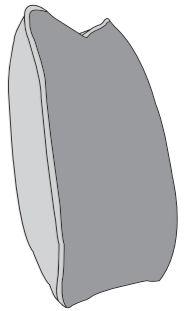

Front = Cover 2  
Back = Cover 1  
Piping = Cover 1

## SUGGESTED ACCENT PIECES

Affinity Swivel Chair (SWC)

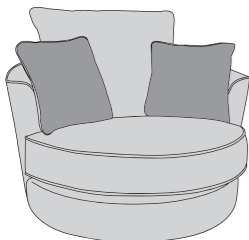



# VARLEY DIMENSIONS (CM)

AVAILABLE PIECES	HEIGHT 1	WIDTH 2	DEPTH 3	SEAT HEIGHT 4	SEAT DEPTH 5	SEAT WIDTH 6	ACCESS DIAGONAL 7	OUTBACK HEIGHT 8	ARM HEIGHT 9	WEIGHT (KG)	SCATTER CUSHION NO.
LH2, COR, RH2 GROUP	89	282	282	47	N/A	N/A	N/A	74	63	134.5	3
LH2, RFC, FST or FST, LFC, RH2	89	282	255	47	N/A	N/A	N/A	74	63	114.5	3
LH2, COR, RH1 GROUP or LH1, COR, RH2 GROUP	89	282	203	47	N/A	N/A	N/A	74	63	129	3
LH1, COR, RH1 GROUP	89	203	203	47	N/A	N/A	N/A	74	63	94.5	3
LH2/RH2 UNIT	89	179	103	47	57	166	204	74	63	50	1
LH1/RH1 UNIT	89	100	103	47	57	86	114	74	63	35	1
LFC/RFC UNIT	89	185	103	47	57	139	208	74	63	48.5	2
LARGE FOOTSTOOL UNIT (FST)	47	70	103	N/A	N/A	N/A	121	N/A	N/A	16	N/A
COR - CORNER UNIT	89	103	103	47	57	57	146	74	63	34.5	1
ALU - ARMLESS UNIT	89	80	103	47	57	80	137	74	63	24.5	N/A
3 SEATER SOFA (3ST)	89	196	103	47	57	164	217	74	63	61	2
2 SEATER SOFA (2ST)	89	168	103	47	57	133	193	74	63	55.5	2
ARM CHAIR (1ST)	89	98	103	47	57	70	138	74	63	41	1
<b>ACCENT PIECES</b>											
AFFINITY SWIVEL CHAIR (SWC)	90	114	111	N/A	N/A	N/A	N/A	N/A	N/A	34	2

\* Hardwood & composite board frame.

\* Dowelled, screwed, glued & stapled joinery.

\* Light and Dark Wood foot options.

\* Fibre filled backs for added comfort.

\* Award winning foamflex seat interior.

\* Serpentine seat springs & silent wire.

\* Superloop back springs.

## DIMENSION GUIDE

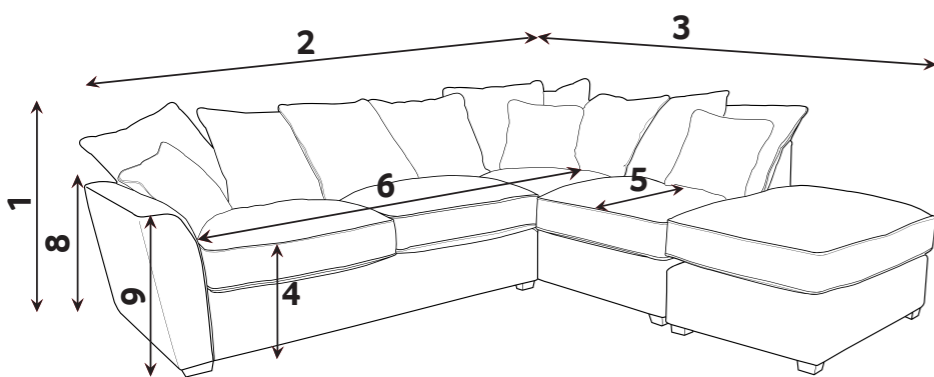

- 1 - HEIGHT
- 2 - WIDTH
- 3 - DEPTH
- 4 - SEAT HEIGHT
- 5 - SEAT DEPTH (STD & PILLOW)
- 6 - SEAT WIDTH

Illustrations used for reference only.

Check the diagonal access dimension to ensure furniture will fit in your home.

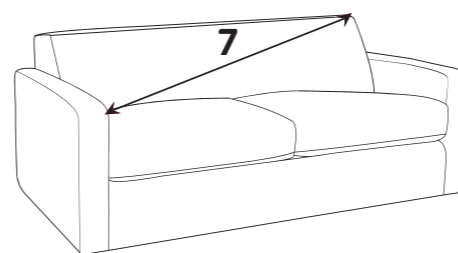

- 7 - DIAGONAL ACCESS
- 8 - OUTBACK HEIGHT
- 9 - ARM HEIGHT

## foamflex™

Our expertly engineered foam seat interior gives you the comfort of fibre with the retention of foam.

## CARE GUIDE

To improve the longevity of your hand-made furniture, we recommend rotating cushions (where applicable).

For further information on maintaining your furniture, please refer to the Care Guide located under the seat platform.



Our foamflex seat interiors have been granted the FIRA GOLD Award, a mark of quality under-pinning all necessary testing of the product materials, design and production techniques.

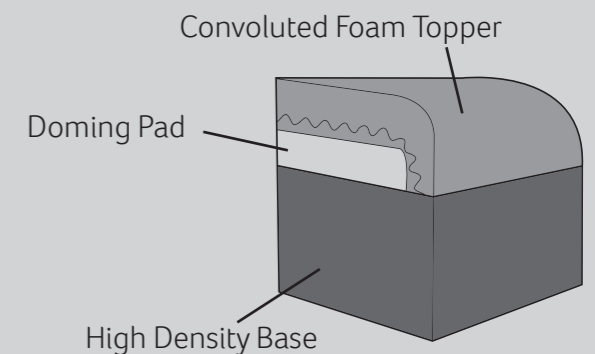

## FOOT OPTIONS:

Dark (Antique)



Light (Beech)



Wood is a natural product and will vary in shade/colour from item to item. Feet require fitting.

Please note : All dimension are approximate. Allow tolerance of +/- 2.5cm.