



Cover 2:  
Whimsical Bronze

Cover 3:  
Galaxy Bronze

Cover 1:  
Titus Truffle

Antique foot

# Pandora Collection

Colours represented are to be used as a guide only.  
Please refer to manufacturers swatch for a more accurate colour match.

Please note that colour shadings can vary slightly from each roll of fabric.  
We cannot guarantee a precise match to these samples or between cut lengths and upholstered goods.

**Extra Flex**<sup>®</sup>  
Soft, Supportive Seating

17/07/2024



# PANDORA COVER GUIDE - STANDARD BACK

Please use this guide when ordering the following pieces to clarify cover options.

## STANDARD BACK

Corner Group: (LH2.COR, RH2)

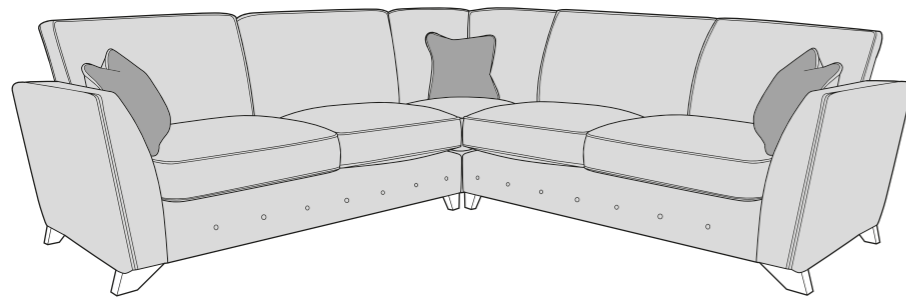

Corner Group: LH2, COR, RH1

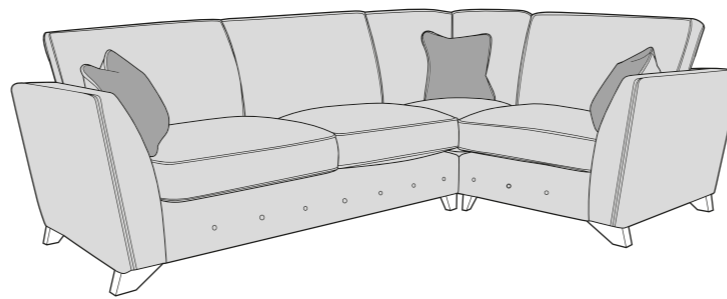

Corner Group: LH1, COR, RH2

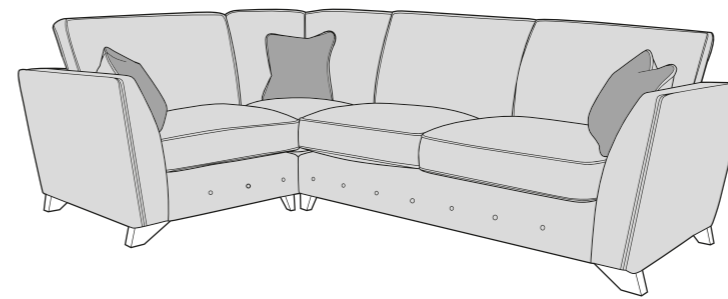

Corner Group: LH1, COR, RH1

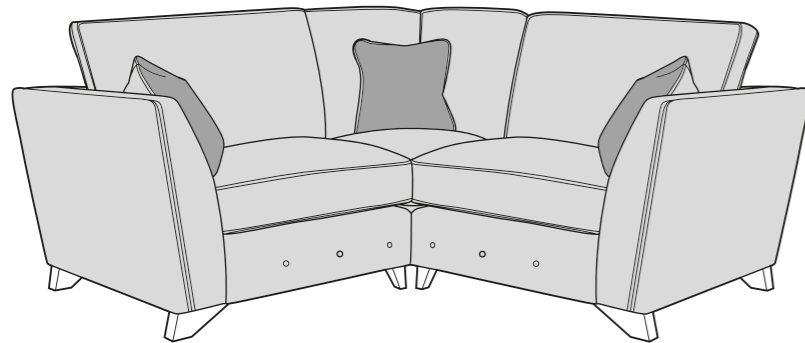

Armless Unit (ALU)

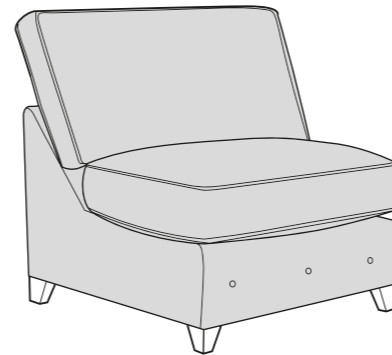

4 Seater Modular (4MD)

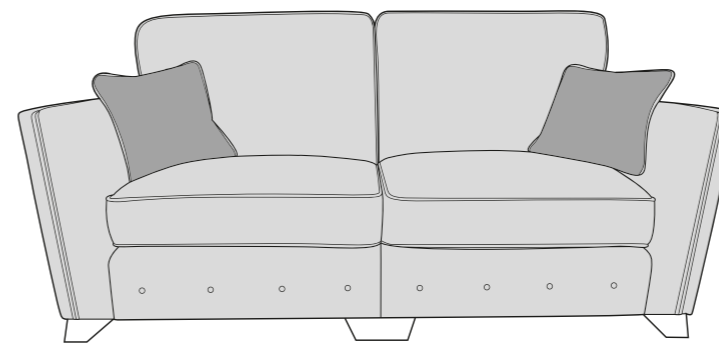

3 Seater Sofa (3ST)

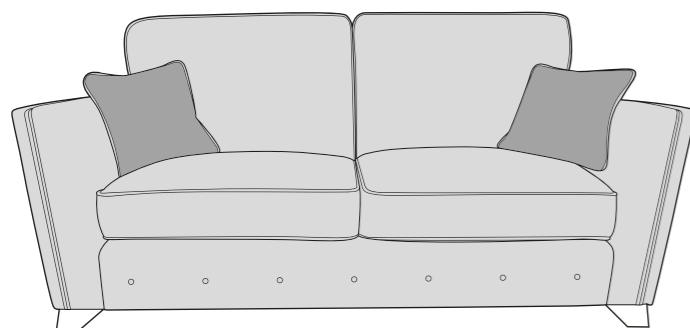

2 Seater Sofa (2ST)

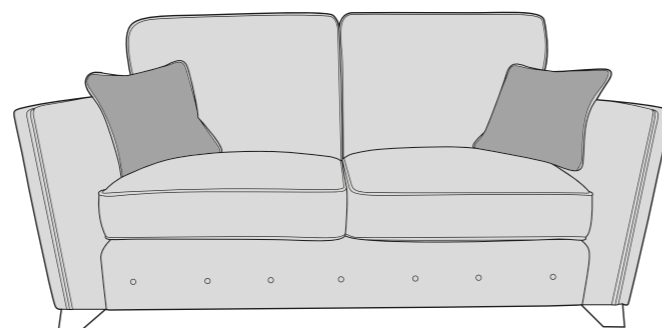

Love Chair (LOV)

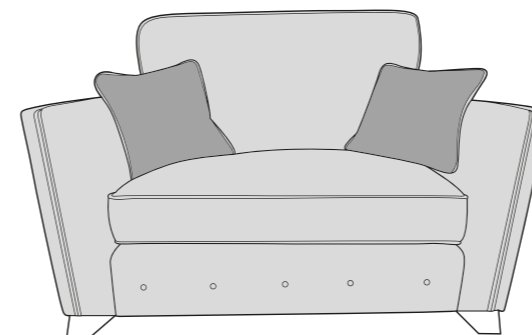

Armchair (1ST)

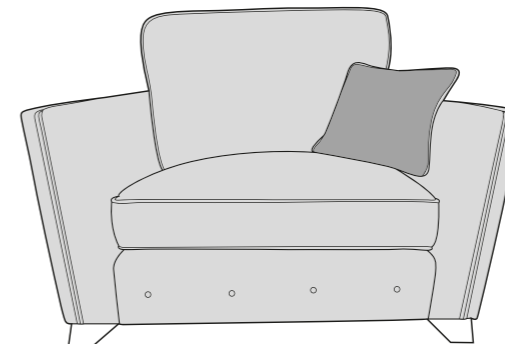

 **COVER 1**  
(BODY)

 **COVER 2**  
(SCATTER)

Standard Back  
Scatter Cushions

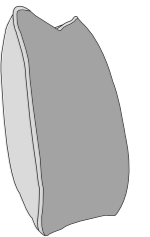

Front = Cover 2  
Piping = Cover 1  
Back = Cover 1

  
**BFM**  
BRITISH FURNITURE  
MANUFACTURERS  
APPROVED MEMBER

  
**ACID**  
ANTI COPYING IN DESIGN

# PANDORA COVER GUIDE - PILLOW BACK

Please use this guide when ordering the following pieces to clarify cover options.

## PILLOW BACK

Corner Group: LH2, COR, RH2

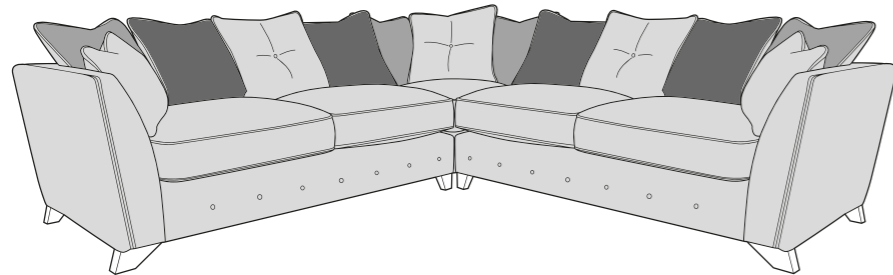

Corner Group: LH2, COR, RH1

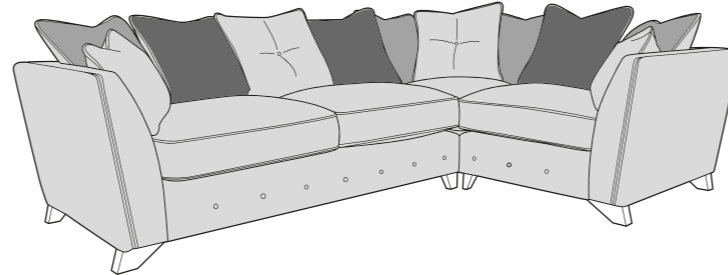

Corner Group: LH1, COR, RH2

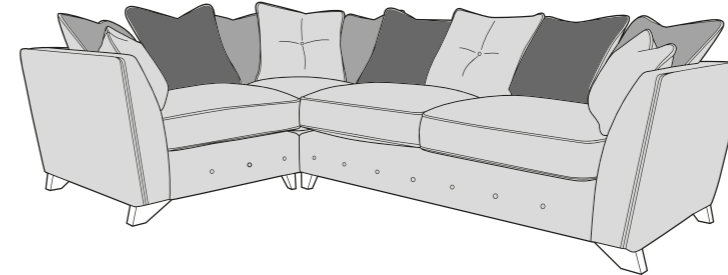

Corner Group: LH1, COR, RH1

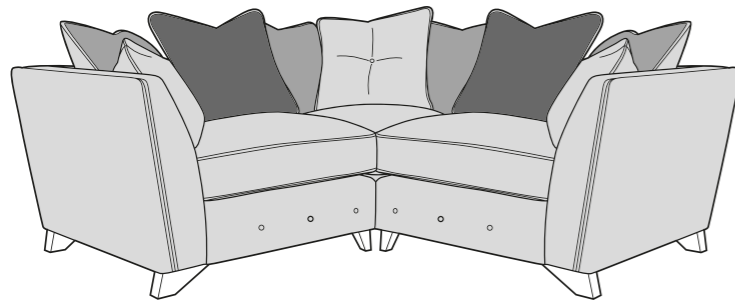

Armless Unit (ALU)

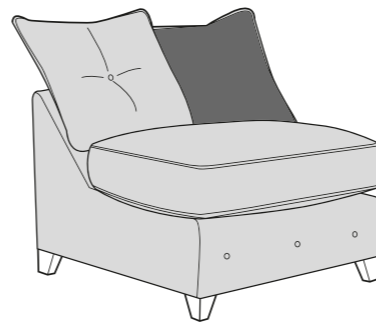

4 Seater Modular Sofa (4MD)

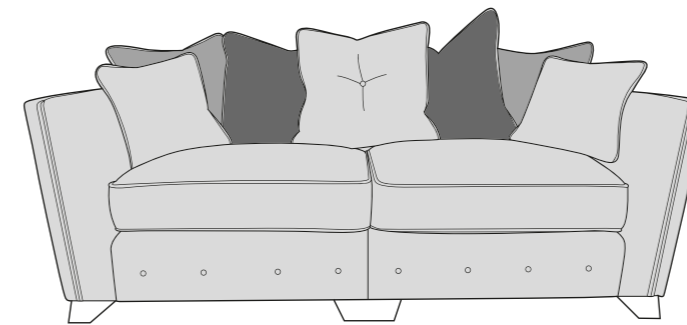

3 Seater Sofa (3ST)

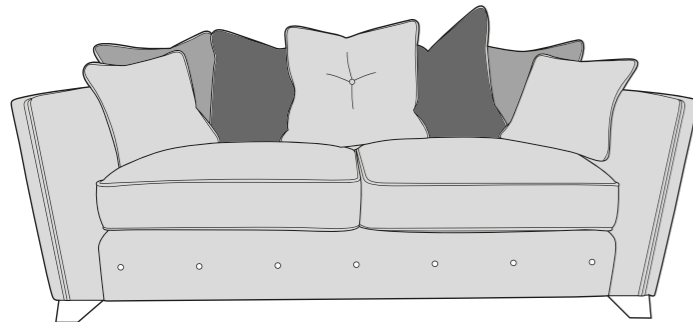

2 Seater Sofa (2ST)

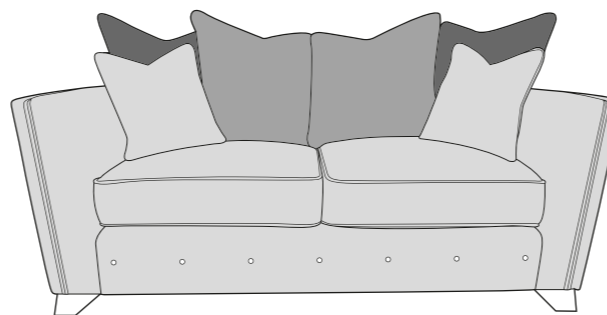

**COVER 1**  
(BODY/  
SCATTER)

**COVER 2**  
(PILLOW)

**COVER 3**  
(PILLOW)

### Pillow Back Cushions

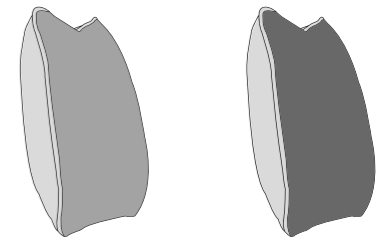

Front = Cover 2    Front = Cover 3  
Piping = Cover 1    Piping = Cover 1  
Back = Cover 1    Back = Cover 1

### Pillow Back Scatter Cushions

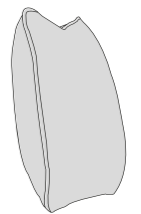

Front = Cover 1  
Piping = Cover 1  
Back = Cover 1

## SUGGESTED ACCENT PIECES

Pandora Accent Chair (ACH)

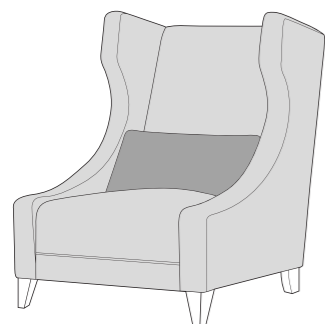

Arc Round Footstool (FST)

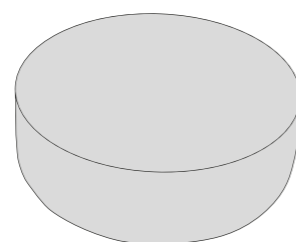

# PANDORA DIMENSIONS (CM)

AVAILABLE PIECES	HEIGHT 1	WIDTH 2	DEPTH 3	SEAT HEIGHT 4	SEAT DEPTH (STD) 5	SEAT DEPTH (PIL) 5	SEAT WIDTH 6	ACCESS DIAGONAL 7	OUTBACK HEIGHT 8	ARM HEIGHT 9	WEIGHT (KG)	PILLOW BACK NUMBER	SCATTER CUSHIONS
LH2, COR, RH2 CORNER GROUP	97	286	286	55	57	54	N/A	N/A	74	74	134	11 (x3 cover 1 / x4 cover 2 / x4 cover 3)	2 (PIL Back) 3 (STD Back)
LH2, COR, RH1 CORNER GROUP or LH1, COR, RH2 CORNER GROUP	97	286	200	55	57	54	N/A	N/A	74	74	116	9 (x2 cover 1 / x4 cover 2 / x3 cover 3)	2 (PIL Back) 3 (STD Back)
LH1, COR, RH1 CORNER GROUP	97	200	200	55	57	54	N/A	N/A	74	74	94	7 (x1 cover 1 / x4 cover 2 / x2 cover 3)	2 (PIL Back) 3 (STD Back)
LH2/RH2 UNIT	97	189	97	55	57	54	169	212	74	74	52	4 (x1 cover 1 / x1 cover 2 / x2 cover 3)	1
LH1/RH1 UNIT	97	103	97	55	57	54	83	141	74	74	34	2 (x1 cover 2 / x1 cover 3)	1
CORNER UNIT (COR)	97	97	97	55	57	54	N/A	137	74	N/A	30	3 (x1 cover 1 / x2 cover 2)	1 (STD Back)
ARMLESS UNIT (ALU)	97	80	97	55	57	54	N/A	125	74	N/A	25	2 (x1 cover 1 / x1 cover 3)	N/A
4ML/4MR UNIT	97	132	97	55	57	54	111	164	74	74	41	3 (x1 cover 1 / x1 cover 2 / x1 cover 3) and 2 (x1 cover 2 / x 1 cover 3)	1
4 SEATER MODULAR SOFA (4MD)	97	264	97	55	57	54	222	281	74	74	82	5 (x1 cover 1 / x2 cover 2 / x2 cover 3)	2
3 SEATER SOFA (3ST)	97	210	97	55	57	54	170	230	74	74	71	5 (x1 cover 1 / x2 cover 2 / x2 cover 3)	2
2 SEATER SOFA (2ST)	97	186	97	55	57	54	143	210	74	74	66	4 (x2 cover 2 / x2 cover 3)	2
LOVE CHAIR (LOV)	97	142	97	55	57	54	99	172	74	74	59	N/A	2
ARMCHAIR (1ST)	97	109	97	55	57	54	69	146	74	74	50	N/A	1
<b>ACCENT PIECES</b>													
PANDORA ACCENT CHAIR (ACH)	111	82	102	43	48	N/A	60	127	N/A	45	37	N/A	1 BOLSTER
ARC ROUND FOOTSTOOL (FST)	33	97	97	N/A	N/A	N/A	N/A	N/A	N/A	N/A	22	N/A	N/A

\* Hardwood & composite board frame.

\* Dowelled, screwed, glued & stapled joinery.

\* Light, Dark & Grey Ash Wood foot options.

\* Feather filled scatter cushions included. 

\* ExtraFlex high comfort seat cushions.

\* Fibre filled backs for added comfort.

\* Serpentine seat springs & silent wire.

\* Elasticated back webbing.

## DIMENSION GUIDE

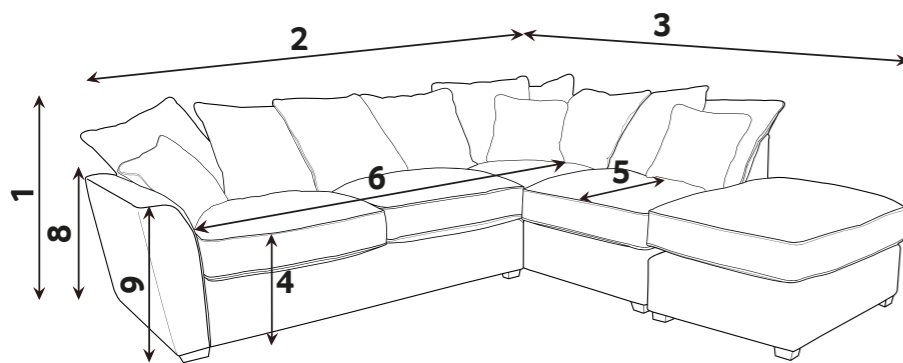

Check the diagonal access dimension to ensure furniture will fit in your home.

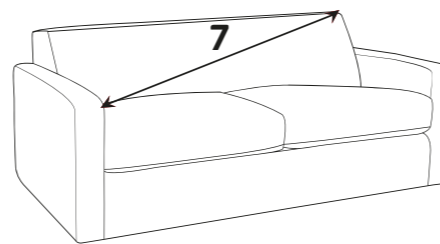

1 - HEIGHT

2 - WIDTH

3 - DEPTH

4 - SEAT HEIGHT

5 - SEAT DEPTH (STD & PILLOW)

6 - SEAT WIDTH

7 - DIAGONAL ACCESS

8 - OUTBACK HEIGHT

9 - ARM HEIGHT

Illustrations used for reference only.

## Extra Flex®

A high density foam base seat interior with a hand-rolled carded fibre, channelled topper which provides both softness and support.

## CARE GUIDE

Extraflex seat cushions should be **plumped up on a regular basis** to help maintain the aesthetic appeal of your upholstery, the plumping of cushions is essential to help retain the comfort and softness of any piece of upholstered furniture.

To improve the longevity of your hand-made furniture, we recommend rotating cushions (where applicable).

For further information on maintaining your furniture please refer to the care guide located under the seat platform.

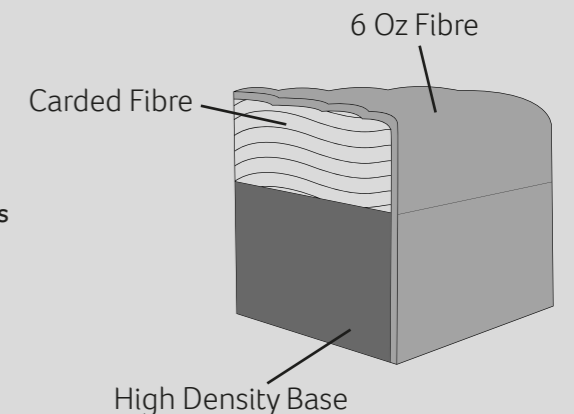

Beech (Light)

4M Centre Foot

Antique (Dark)

4M Centre Foot

Grey Ash

4M Centre Foot

FOOT OPTIONS:

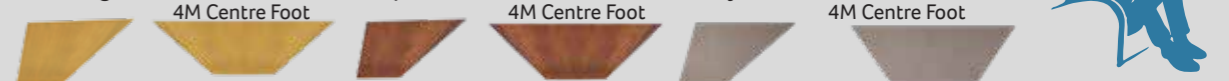

Please note : All dimension are approximate. Allow tolerance of +/- 2.5cm.

Wood is a natural product and will vary in shade/colour from item to item. Feet may require fitting.

17/07/2024