



Cover 1:  
Aaron Silver

Cover 2:  
Denny Pebble

Cover 3:  
Whimsical Bronze

Chrome Feet

# Chicago Collection

Colours represented are to be used as a guide only.  
Please refer to manufacturers swatch for a more accurate colour match.

Please note that colour shadings can vary slightly from each roll of fabric.  
We cannot guarantee a precise match to these samples or between cut lengths and upholstered goods.

**Extra Flex**<sup>®</sup>  
Soft, Supportive Seating

26/03/2024

# CHICAGO COVER GUIDE - STANDARD BACK

Please use this guide when ordering the following pieces to clarify cover options.

## STANDARD BACK

Corner Group: LH2, RFC, FST

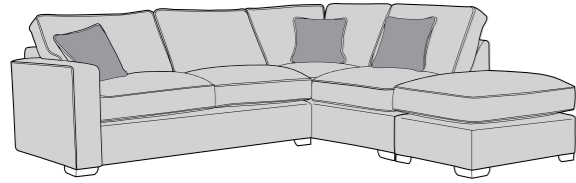

Corner Group: FST, LFC, RH2

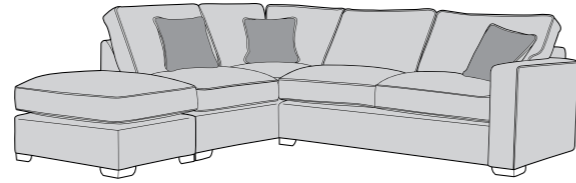

Corner Group: L2S, RFC, FST

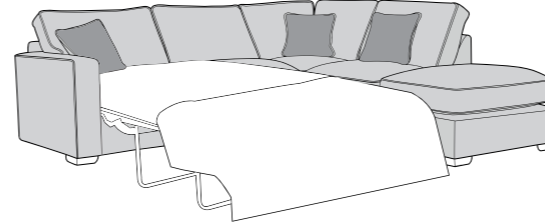

Corner Group: FST, LFC, R2S

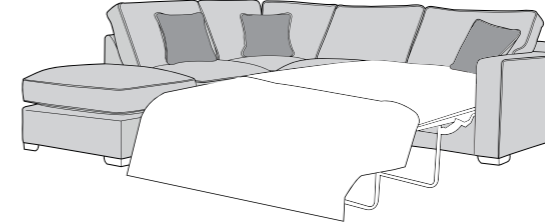

Corner Group: LH2, COR, RH1

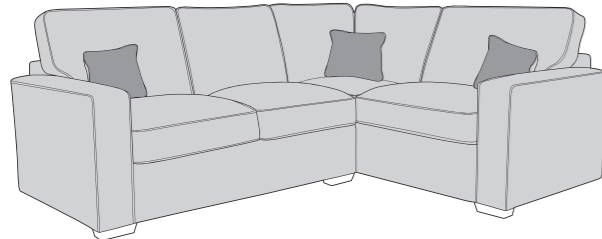

Corner Group: LH1, COR, RH2

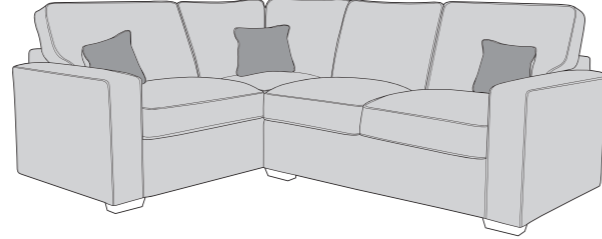

Corner Group: L2S, COR, RH1

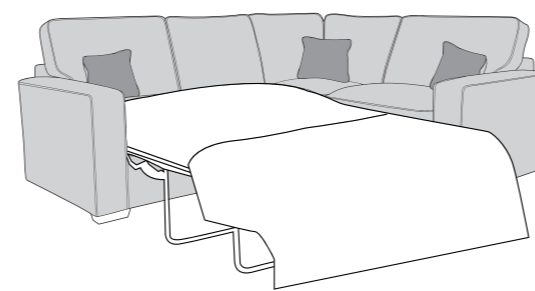

Corner Group: LH1, COR, R2S

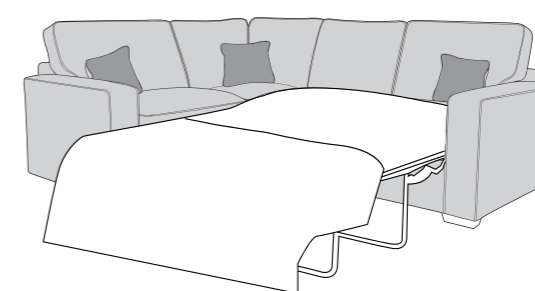

Corner Group: LH2, RTC

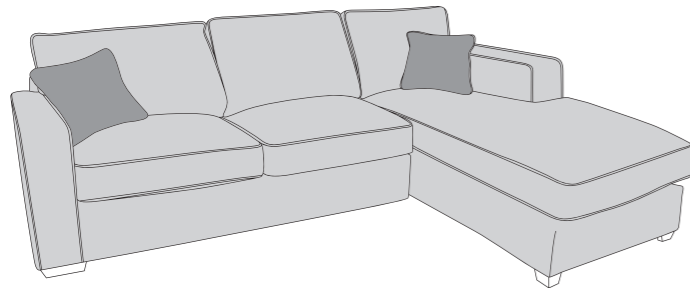

Corner Group: LTC, RH2

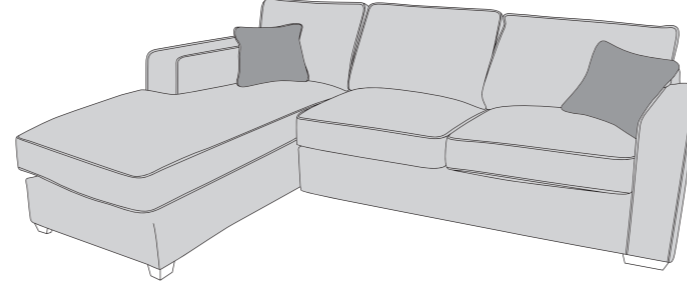

Corner Group: LH2, COR, RH2

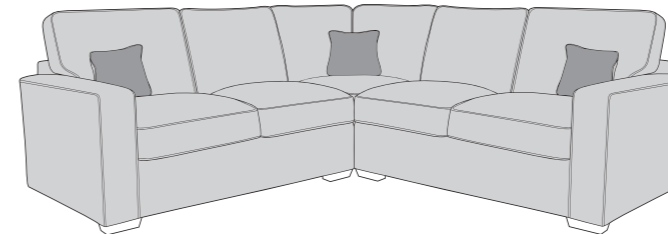

Corner Group: LH1, COR, RH1

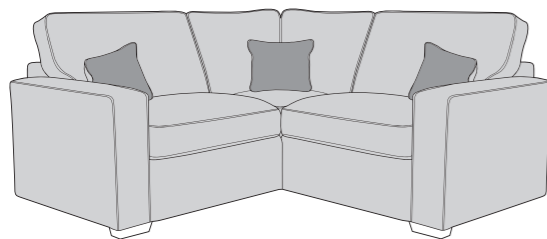

Armless Unit (ALU)

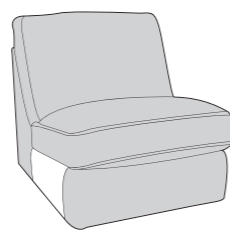

Large Footstool (FST)

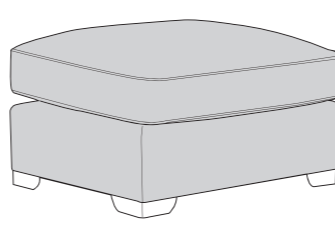

3 Seater sofa (3ST)

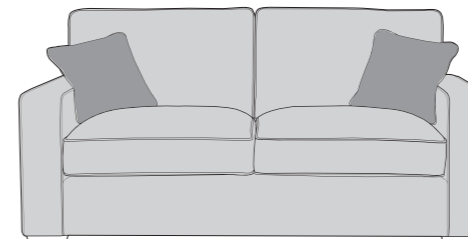

2 Seater sofa (2ST)

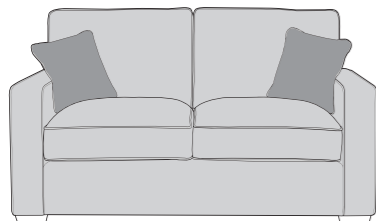

Love Chair (LOV)

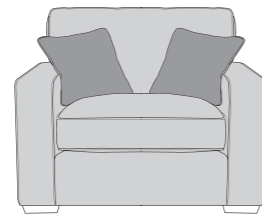

Arm Chair (1ST)

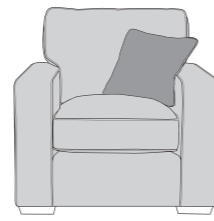

3 Seater Sofa Bed (3SB, 3DB)

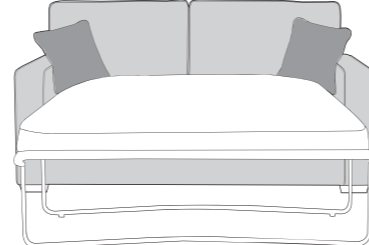

2 Seater Sofa Bed (2SB, 2DB)

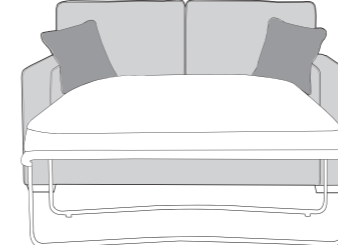

Chair Sofa Bed (1SB, 1DB)

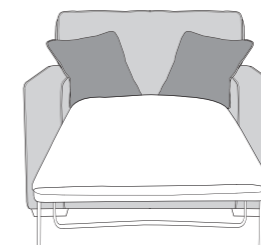

**COVER 1**  
(BODY)

**COVER 2**  
(SCATTER)

Standard Back  
Scatter Cushions

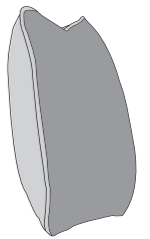

Front = Cover 2  
Piping = Cover 1  
Back = Cover 1

**BFM**  
BRITISH FURNITURE  
MANUFACTURERS  
APPROVED MEMBER

**A©ID**  
ANTI COPYING IN DESIGN

# CHICAGO COVER GUIDE - PILLOW BACK

Please use this guide when ordering the following pieces to clarify cover options.

## PILLOW BACK

LH2, RFC, FST Group

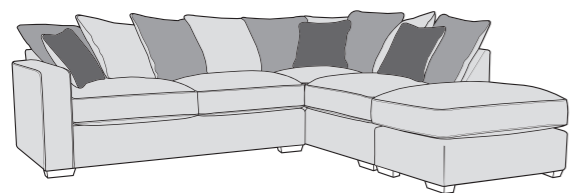

FST, LFC, RH2 Group

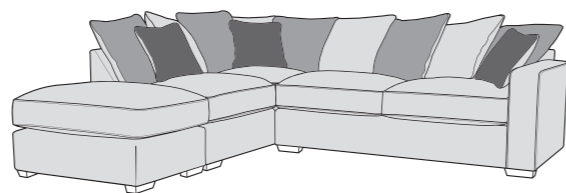

L2S, RFC, FST Group

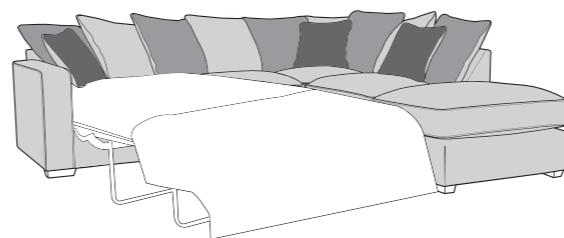

FST, LFC, R2S Group

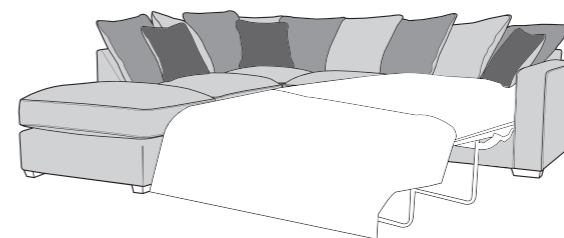

LH2, COR, RH1 Group

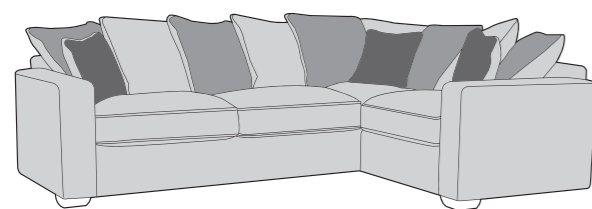

LH1, COR, RH2 Group

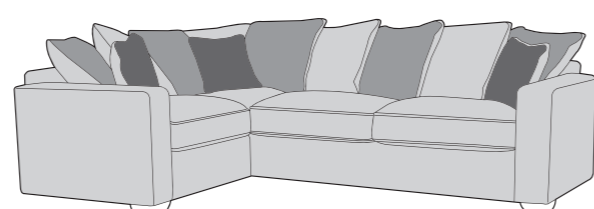

L2S, COR, RH1 Group

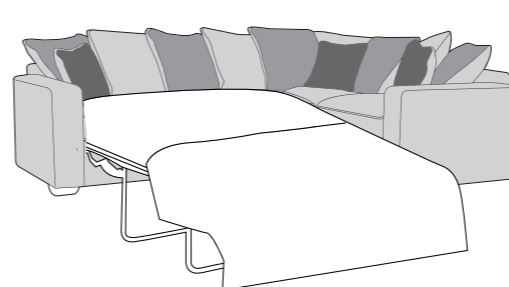

LH1, COR, R2S Group

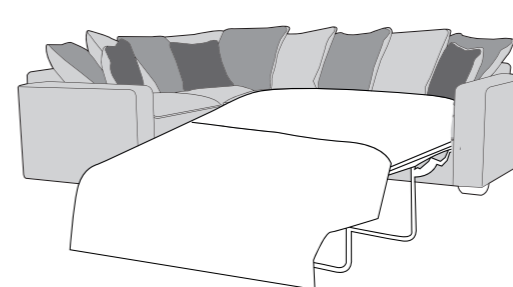

Corner Group: LH2, RTC

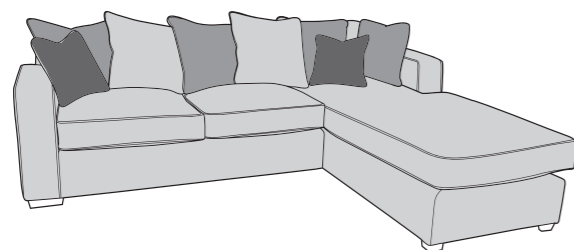

Corner Group: LTC, RH2

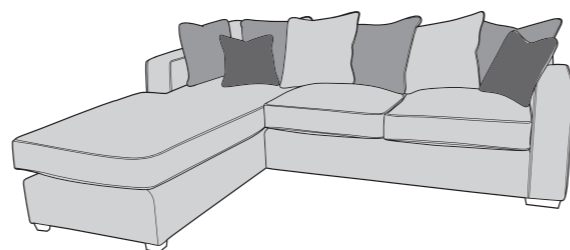

LH2, COR, RH2 Group

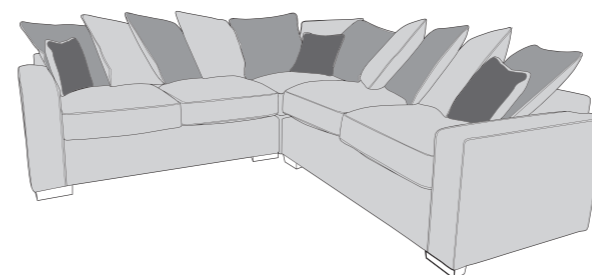

LH1, COR, RH1 Group

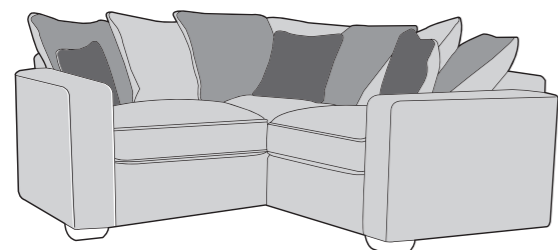

Armless Unit (ALU)

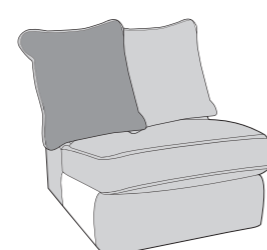

Large Footstool (FST)

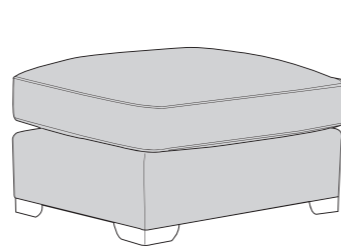

3 Seater Sofa (3ST)

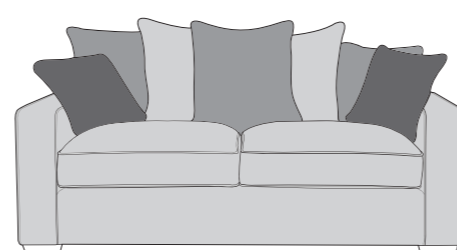



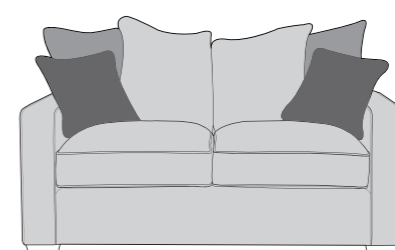

2 Seater Sofa (2ST)

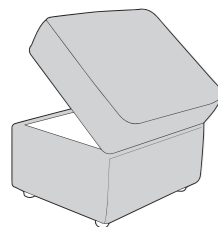

## ACCENT PIECES

Storage Footstool (FSS)



-  **COVER 1**  
(BODY)
-  **COVER 2**  
(PILLOW)
-  **COVER 3**  
(SCATTER)

### Pillow Back Cushions

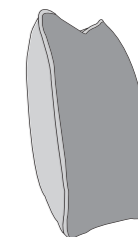

Front = Cover 2  
Piping = Cover 1  
Back = Cover 1

### Pillow Back Scatter Cushions

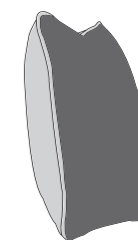

Front = Cover 3  
Piping = Cover 1  
Back = Cover 1



# CHICAGO DIMENSIONS (CM)

AVAILABLE PIECES	HEIGHT 1	WIDTH 2	DEPTH 3	SEAT HEIGHT 4	SEAT DEPTH (STD) 5	SEAT DEPTH (PILLOW) 5	SEAT WIDTH 6	ACCESS DIAGONAL 7	WEIGHT (KG)	PILLOW BACK NO.	SCATTER CUSHION NO.
LH2, RFC, FST GROUP or RH2, LFC, FST GROUP	96	276	247	N/A	N/A	N/A	N/A	N/A	120	9 (5 pattern/4 plain)	3
L2S, RFC, FST GROUP or R2S, LFC, FST GROUP	96	247	250	N/A	N/A	N/A	N/A	N/A	128	9 (5 pattern/4 plain)	3
LH2, COR, RH1 or LH1, COR, RH2 GROUP	96	275	197	N/A	N/A	N/A	N/A	N/A	111	9 (5 pattern/4 plain)	3
L2S, COR, RH1 or R2S, COR, LH1 GROUP	96	247	197	N/A	N/A	N/A	N/A	N/A	109	9 (5 pattern/4 plain)	3
LH2,RTC or LTC,RH2 GROUP	96	280	161	N/A	N/A	N/A	N/A	N/A	80.5	7(4 pattern/3 plain)	2
LH2, COR, RH2 GROUP	96	275	275	N/A	N/A	N/A	N/A	N/A	128	11 (6 pattern/5 plain)	3
LH1, COR, RH1 GROUP	96	197	197	N/A	N/A	N/A	N/A	N/A	94	7 (4 pattern/3 plain)	3
LH2/RH2 UNIT	96	182	98	55	55	58	162	205	49	4 (2 pattern/2 plain)	1
L2S/R2S BED ACTION	96	154	98	55	55	58	133	178	57	4 (2 pattern/2 plain)	1
LH1/RH1 1 SEAT ARM UNIT	96	104	98	55	55	58	80	138	32	2 (1 pattern/1 plain)	1
LFC/RFC UNIT	96	177	98	55	55	58	140	198	53	5 (3 pattern/2 plain)	2
LTC/RTC UNIT	96	100	161	55	112	58	79	188	31.5	3 (2 pattern/1 plain)	1
ALU (ARMLESS) UNIT	96	80	98	55	55	58	80	120	21	2 (1 pattern/1 plain)	N/A
COR (CORNER) UNIT	96	93	93	55	55	58	93	125	30	3 (2 pattern/1 plain)	1
FST (LARGE FOOTSTOOL) UNIT	55	98	73	56	55	58	N/A	115	18	N/A	N/A
3 SEATER SOFA (3ST)	96	198	98	55	55	58	160	217	56	5 (3 pattern/2 plain)	2
2 SEATER SOFA (2ST)	96	171	98	55	55	58	133	198	49	4 (2 pattern/2 plain)	2
LOVE CHAIR (LOV)	96	130	98	55	55	N/A	90	161	44	N/A	2
ARM CHAIR (1ST)	96	98	98	55	55	N/A	60	133	34.5	N/A	1
<b>SOFA BEDS - STD BACK ONLY</b>											
3S (140CM SOFA BED) STANDARD	96	188	98	55	55	N/A	149	208	82.5	N/A	2
2S (120CM SOFA BED) STANDARD	96	168	98	55	55	N/A	129	193	74.5	N/A	2
1S (80CM SOFA BED) STANDARD	96	130	98	55	55	N/A	90	161	64.5	N/A	2
3D (140CM SOFA BED) DELUXE	96	188	98	55	55	N/A	149	208	104	N/A	2
2D (120CM SOFA BED) DELUXE	96	168	98	55	55	N/A	129	193	95	N/A	2
1D (80CM SOFA BED) DELUXE	96	130	98	55	55	N/A	90	161	88	N/A	2
OPEN DEPTH OF SOFA BEDS 226CM											
<b>ACCENT PIECES</b>											
STORAGE FOOTSTOOL (FST)	45	63	50	N/A	N/A	N/A	N/A	75	12.5	N/A	N/A

- \* Hardwood & composite board frame.
- \* Dowelled, screwed, glued & stapled joinery.
- \* Gold, Chrome & Wood foot options.

- \* ExtraFlex high comfort seat cushions.
- \* Fibre filled backs for added comfort.

- \* Serpentine seat springs & silent wire.
- \* Elasticated back webbing.

## SOFABEDS: 2 SLEEP OPTIONS

### STANDARD ACTION & FOAM MATTRESS

A three fold metal action with a sprung 'polyprop' base. Complemented by a high performance foam mattress. For occasional use only.

**Mattress Thickness: 6cm**  
**Mattress Length: 185cm**

**3 fold action is 140Kg total max occupancy weight**

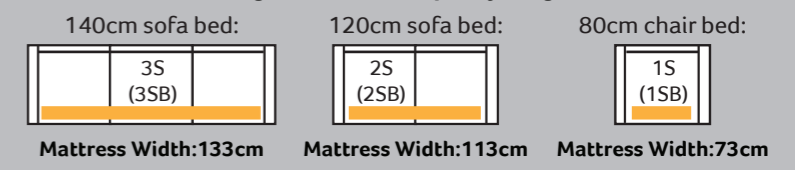

### DELUXE ACTION & SPRUNG MATTRESS

A two fold metal action with beech slats. Complemented by a deluxe sprung mattress. For everyday use.

**Mattress thickness: 11.5cm**  
**Mattress Length: 183cm**

**2 fold action is 160Kg total max occupancy weight**

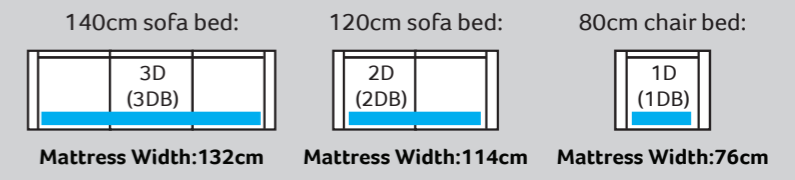

Sofa beds available as standard back only

### DIMENSION GUIDE

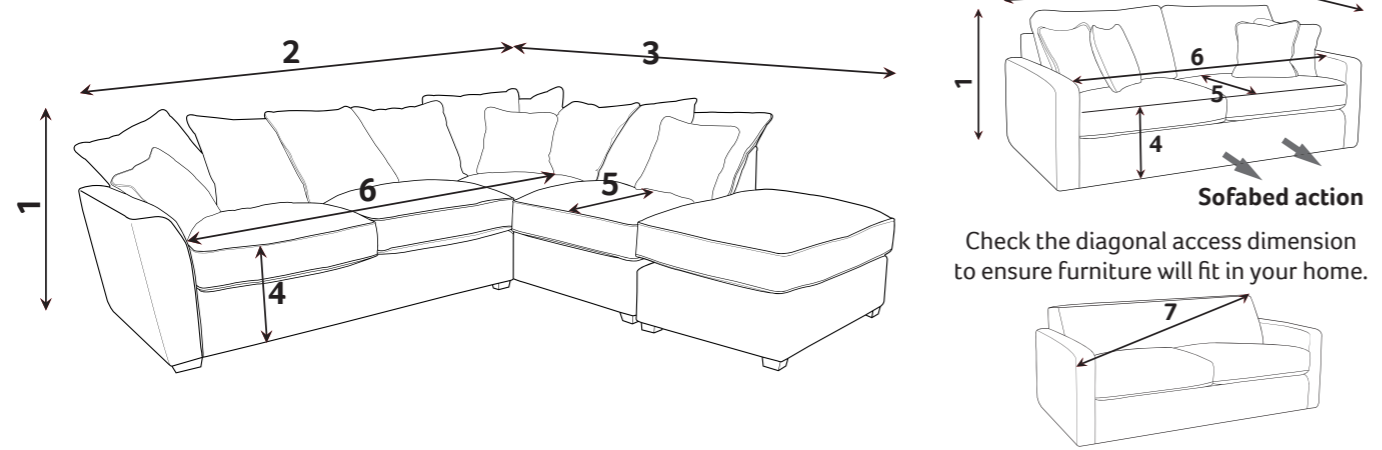

- 1 - HEIGHT
- 2 - WIDTH
- 3 - DEPTH
- 4 - SEAT HEIGHT
- 5 - SEAT DEPTH (STD & PILLOW)
- 6 - SEAT WIDTH
- 7 - DIAGONAL ACCESS

Illustrations used for reference only.

## Extra Flex®

A high density foam base seat interior with a hand-rolled carded fibre, channelled topper which provides both softness and support.

### CARE GUIDE

Extraflex seat cushions should be plumped up on a regular basis to help maintain the aesthetical appeal of your upholstery, the plumping of cushions is essential to help retain the comfort and softness of any piece of upholstered furniture.

To improve the longevity of your hand-made furniture, we recommend rotating cushions (where applicable).

For further information on maintaining your furniture please refer to the care guide located under the seat platform.

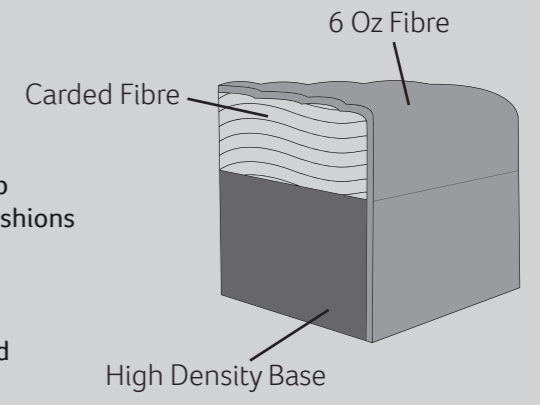

- Beech (Light)
- Mid Oak
- Brown (dark)
- Chrome
- Gold

### FOOT OPTIONS:



Wood is a natural product and will vary in shade/colour from item to item. Feet may require fitting.

Please note : All dimensions are approximate. Allow tolerance of +/- 2.5cm.

